



INSTALLATION AND OPERATING INSTRUCTIONS

安裝使用說明書

Thermo Ventilator

浴室換氣暖風機

Model No.

型號：30BWBH

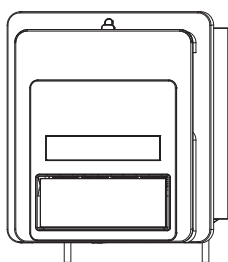

CONTENTS

SAFETY INSTRUCTIONS 2

INSTALLATION INSTRUCTIONS 3~4

INSTALLATION REQUIREMENTS 5~6

SUPPLIED ACCESSORIES 6

PART NAMES AND DIMENSIONS 7

HOW TO INSTALL 7~14

TEST RUN 15

FUNCTION OF REMOTE CONTROL 15

HOW TO USE TIMER FUNCTION 16

HOW TO USE AIR DIRECTION FUNCTION 17

HOW TO USE HEATING FUNCTION 18

HOW TO USE DRYING FUNCTION 19

HOW TO USE VENTILATION FUNCTION 19

CARE MODE:

HOW TO USE WARM BATH FUNCTION 20

HOW TO USE REFRESH FUNCTION 21

HOW TO USE 24HR VENT. FUNCTION 21

HOW TO USE DRY CLOTH FUNCTION 22~24

MODE BUTTON PANEL ON MAIN BODY 25

USE AND MAINTENANCE INSTRUCTIONS 26~28

MAINTENANCE 28~29

ANTIBACTERIAL FUNCTION 30

TROUBLESHOOTING 30

WIRING DIAGRAM 31

SPECIFICATIONS BACK COVER

目錄

安全指引 2

安裝注意事項 3~4

安裝要求 5~6

包裝附件清單 6

部件名稱和尺寸 7

安裝方法 7~14

試運轉 15

遙控器功能 15

定時功能的使用方法 16

風向功能的使用方法 17

暖氣功能的使用方法 18

乾燥功能的使用方法 19

換氣功能的使用方法 19

貼心模式：

溫暖沐浴功能的使用方法 20

極速排氣功能的使用方法 21

24小時換氣功能的使用方法 21

高效乾衣功能的使用方法 22~24

機體模式按鈕面板 25

使用及維護注意事項 26~28

維護方法 28~29

抗菌功能 30

常見故障的識別與處理 30

電氣原理圖 31

規格 末頁

Thank you for purchasing this KDK product.

Please read these instructions carefully before attempting to install, operate or service the KDK product. Please carefully read "INSTALLATION INSTRUCTIONS" (P.3~4) of this instructions before installation. Failure to comply with instructions could result in personal injury or property damage. Please explain to users how to operate and maintain the product after installation, and this booklet should be presented to users. Please carefully read "USE AND MAINTENANCE INSTRUCTIONS" (P.26~28) of this instructions before operation.

Please retain this booklet for future reference.

感謝您選用KDK產品。

安裝、使用和保養KDK產品前，請仔細閱讀本安裝使用說明書。安裝前，請務必先閱讀“安裝注意事項”（第3~4頁）。不遵照此說明書進行操作有可能導致人員受傷或財產損失。安裝完成後，請向顧客說明如何使用和維護KDK產品，並將此說明書交給顧客保管。使用前，請務必先閱讀“使用及維護注意事項”（第26~28頁）。請妥善保管好此說明書以備日後參考。

Disconnect power supply before maintenance.

維護保養前先斷電。

This appliance is not intended for use by persons (including children) with reduced physical, sensory or mental capabilities, or lack of experience and knowledge, unless they have been given supervision or instruction concerning use of the appliance by a person responsible for their safety. Children should be supervised to ensure that they do not play with the appliance.

本產品不適合有殘疾、智障或精神障礙的人士或缺乏經驗、常識者（包括兒童）維護使用，除非在負責他們安全的人士的看護或指導下使用。在維護保養期間，兒童應該有人進行看護，以防將產品當作玩具。

The following instructions should be strictly observed in order to prevent injury to the users and other people, or damage to property.

為避免給您及其他人造成傷害，這裡我們列出了以下安全注意事項，請務必遵守，各種標誌的含意請參見以下內容。

- The degrees of injury or damage that can occur when the instructions are ignored and if the product is not used properly have been classified and described by the following indications.

對無視表示內容，錯誤地使用時，會引起的危害或損傷的程度，用下列符號進行分類、說明。



WARNING

警告

This indication means: Must be treated seriously that this may result in death or serious injury.

本標誌所表示內容為“不遵守的話可能造成人員死亡或重傷”。



CAUTION

注意

This indication means: Must be treated seriously that this may result in injury or physical damage.

本標誌所表示內容為“不遵守的話可能造成人身輕傷或其他財產損害”。

- Types of instructions that should be observed have been classified and described by the following pictorial symbols.

對希望遵守的內容和種類，用下列符號進行分類、說明。



This symbol indicates the item is “PROHIBITED” to do.

此標誌表示為禁止事項



This symbol indicates the “COMPULSORY” item that must be followed without failure.

此標誌表示為強制事項



This symbol indicates the item is “CAUTION”.

此標誌表示為提示注意事項

INSTALLATION INSTRUCTIONS

安裝注意事項

WARNING 警告

- Do not close to curtains and other flammable materials when install the product.

禁止靠近窗簾和其他可燃材料安裝。



Otherwise, combustibles may be inflamed.

否則可能會引燃可燃物。

- Do not install the product as the method which is not approved in the instruction.

禁止使用本說明書指定以外的方法進行安裝。



Otherwise, unreliable installation may be caused and thus the product may fall off, resulting in injuries.

否則可能會安裝不牢固，導致產品掉落受傷。

- To avoid danger arising from wrong resetting of the thermal circuit breaker, the product can not be powered by using an external switch. For example, by a timer or connecting to a circuit that is connected/disconnected through timing of a universal part.

為避免由熱斷路器的誤復位產生危險，產品不能通過外部開關裝置供電。例如，定時器或者連接到由通用部件定時進行通、斷的電路。



Otherwise, a fire may be caused.

否則可能會導致火災。

- Do not operate the product other than the rated voltage (220 V~, 50 Hz).

禁止使用額定電壓(220 V~, 50 Hz)以外的電壓。



Otherwise, it may cause damages to the product or a fire.

否則可能會損壞本產品或導致火災。

- The product can not be located just below a power outlet socket.

禁止把本產品安放在電源插座下使用。



Otherwise, a fire may be caused.

否則可能會導致火災。

- The product must be grounded.
必須接地。



Otherwise, it may cause electric shock when there is any trouble or electric leakage.

當出現故障或漏電時，可能會觸電。

- Do avoid the back-flow of gas into the room from the open flue of flammable gas or other open-fire appliances.

必須避免易燃氣體從敞開的氣道或其他燃燒燃料的設備回流進室內。



Otherwise, a fire may be caused.

否則可能會導致火災。

- Please install an all-pole switch which the contact separation is more than 3 mm and the capacity more than 250 V~ 13 A to control the power of the product. Please install the all-pole switch out of the bathroom where it is easily controlled.

安裝時，須在供電線路中安裝其觸點開距不少於3 mm的“電源全級開關”，以用於接通或斷開主機電源，其額定負載能力不小於250 V~ 13 A，且安裝在浴室外側方便操作的地方。



Otherwise, it may cause a short circuit, thus resulting a fire.

否則可能會導致短路，導致火災。

- Please select 60227 IEC 53 (RVV) ordinary polyvinyl chloride sheathed cord. Nominal cross-sectional area of conductors is $3 \times 1.5 \text{ mm}^2$.

電源線請選用60227 IEC 53(RVV)型軟線，導線的截面積為 $3 \times 1.5 \text{ mm}^2$ 。



Otherwise, it may be on fire.

否則可能會導致起火。

- Make sure the power cord is installed firmly.

確保電源線安裝到位。



Otherwise, a fire may be caused.

否則可能會導致火災。

INSTALLATION INSTRUCTIONS

安裝注意事項



WARNING 警告

- Disconnect power source before working on the product.

安裝、維修保養時必須斷開電源。



Otherwise, an electric shock may be caused.

否則可能會導致觸電。

- Installation and wiring should be done by authorized person. (wiring is required to follow the local wiring regulations.)

安裝及電源佈線必須由專業人員完成。

(產品安裝必須符合當地的安全法規。)



Otherwise, a fire may be caused.

否則可能會導致火災。

- The product is installed so that switches cannot be touched by a person in the bath or shower.

產品的安裝，應使得浴缸內或淋浴區的人不能夠觸及到開關。



Otherwise, an electric shock may be caused.

否則可能會導致觸電。



CAUTION 注意

- Do not reconstruct this product.

禁止對本產品進行改造。



Otherwise, it may cause damage to the product.

否則可能會導致產品損壞。

- Do fix this product tightly.

機體安裝必須牢固。



Otherwise, it may fall off or cause personal injury.

否則可能會掉落，導致受傷。

- Components must be installed tightly.

部品安裝必須牢固。



Otherwise, it may fall off or cause personal injury.

否則可能會掉落，導致受傷。

- It is recommended that two persons perform the installation of the product.

建議兩人進行產品的安裝作業。



Otherwise, it may cause the product to fall off.

否則可能會導致產品掉落。

- Do not install it on window without sufficient strength. It must be subject to 5 times the weight of the product. If you cannot ensure the installation strength, be sure to adopt reinforcement measure.

產品必須安裝在強度足夠的窗體上，需可承受產品5倍的重量，如不能確保安裝強度，請務必採取加固措施。



Otherwise, it may fall off or cause personal injury.

否則可能會掉落，導致受傷。

- The special-purpose or dedicated parts, such as mounting fixtures, must be used if such parts are provided.

有安裝五金件等專用零部件時，應使用專用零部件。



Otherwise, unreliable installation may be caused and thus the product may fall off.

否則可能會安裝不牢固，導致產品掉落。

INSTALLATION REQUIREMENTS

安裝要求

- Do not install onto slanting window.
請勿安裝在傾斜的窗體上。



Prevent the water condensed in the duct pipe flow back into the body.
防止水倒流。

- Do not install the product in steam sauna bathroom.
請勿安裝在桑拿蒸氣浴室中。



Maybe it can cause breakdown.
可能會引起故障。

- Do not install the product in the places where the sprayer is used.
請勿安裝在使用噴霧器的場所。

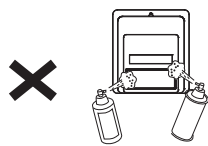

Maybe it can cause breakdown.
可能會引起故障。

- Do not install the product in places with high temperature.
請勿安裝在高溫的環境下。

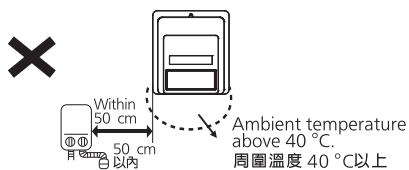

Maybe it can cause breakdown.
可能會引起故障。

- Please set ventilation holes.
請設置通風口。

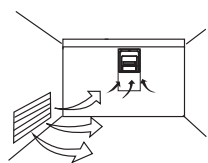

- The product is not provided with power cord, all-pole switch and leakage protection switch. Please purchase them in market.
本產品沒有提供電源線，電源全極開關和漏電保護開關，需用戶另購。

- Please make sure the product installed horizontally and the deviation angle within the range as below figure.

請確保整機水平安裝偏差角度在下圖所示範圍內。

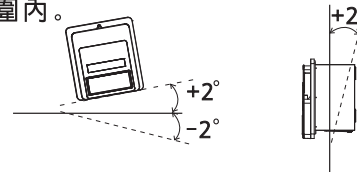

- Do not install the product in the places where the organic solvent is used.
請勿安裝在使用有機溶劑的場所。

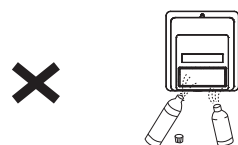

Maybe it can cause breakdown.
可能會引起故障。

- Do not install the product where it is exposed to oil mist.
請勿安裝在油煙過多的場所。



Maybe it can cause breakdown.
可能會引起故障。

- The product must be installed over 1.8 m above the floor.
產品安裝高度距地面必須大於1.8 m。

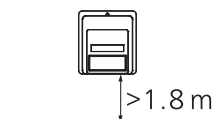







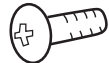

INSTALLATION REQUIREMENTS

安裝要求

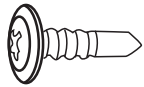
- Do not cover air outlet, maybe it can cause breakdown.
請勿覆蓋產品出風口，否則可能會引起機體故障。
- When you install plastic part, do not exert too much strength to fixing the screw, otherwise, the product would be damaged.
安裝塑料部件時，為了不損壞產品，鎖螺絲時請注意不要用力過大。
- Do not install this product in a public bath room.
請勿把本產品安裝在公共浴室。
- Do not install this product in a wardrobes.
請勿把本產品安裝在衣櫃內。
- In extreme weather condition (rainfall precipitation more than 240 mm/h. wind speed higher than No.8 typhoon.), there may be water through frame into bathroom.
在極端惡劣的天氣條件下(雨量大於240 mm/h，風速大於8號風球)，可能有水通過產品框架進入浴室內部。

SUPPLIED ACCESSORIES

包裝附件清單

No. 代號	Drawing 圖樣	Name and purpose 名稱及用途	Qty 數量
①		Machine screw (M4×10, used to install the louver assembly) 機械螺絲 (M4×10用於面板組合安裝)	1
②		Self-tapping screw (∅4×16, used to install the controller holder) (placed on the backside of controller holder) 自攻螺絲 (∅4×16用於遙控器底座安裝) (放置於遙控器底座背面)	2
③		Self-tapping screw (∅4×25, used to install the main body and the window) 自攻螺絲 (∅4×25用於機體與窗體的安裝)	4
④		Product warranty registration 產品保修登記	1
⑤		Installation and operating instructions 安裝使用說明書	1
⑥		Louver assembly 面板組合	1
⑦		Remote control assembly 遙控器組合	1
⑧		R03(AAA) Carbon battery R03(AAA)碳性電池	2

PART NAMES AND DIMENSIONS

部件名稱和尺寸

Unit: mm 單位: mm

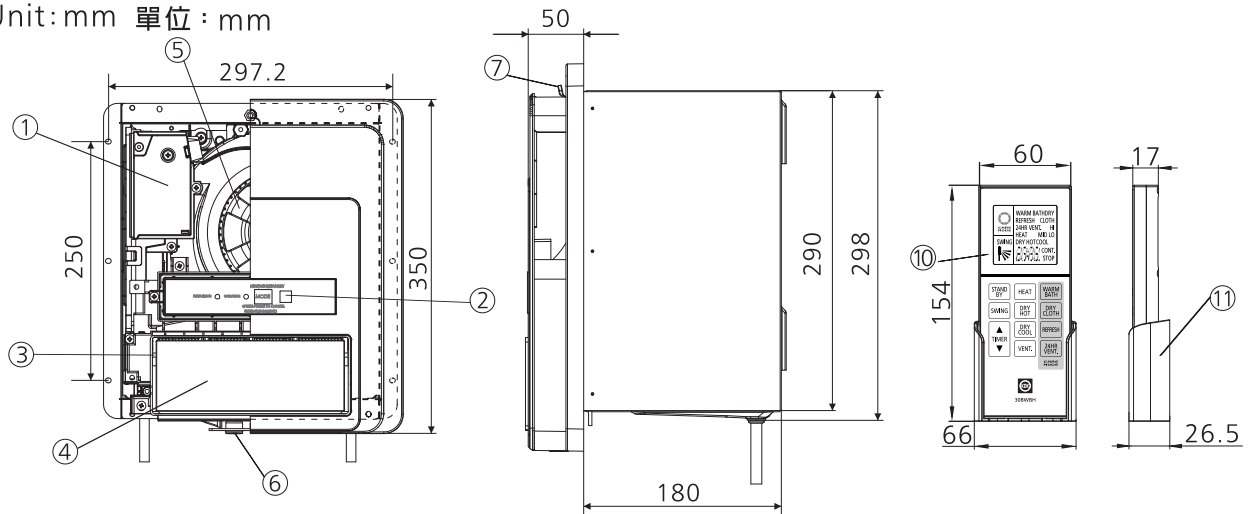

No. 序號	Part name 部件名稱	No. 序號	Part name 部件名稱
①	Cord cover 接線蓋板	⑦	Filter assembly 過濾網
②	Signal receiver 信號接收器	⑧	Louver assembly 面板組合
③	Heater assembly 加熱器組合	⑨	Main body 機體
④	Baffle plate 導風板	⑩	Remote control 遙控器
⑤	Fan 扇葉	⑪	Controller holder 遙控器底座
⑥	AIRDIR. handle 風向調節把手		

HOW TO INSTALL

安裝方法

1. Installation diagram (Top View) 安裝俯視示意圖

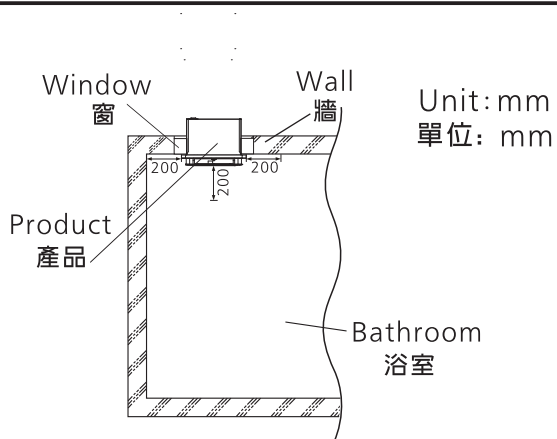

Notice 提示事項

Install this product over 200 mm apart from curtains or other flammable materials.
離窗簾和其他易燃材料距離200 mm以上。

HOW TO INSTALL

安裝方法

2. Recommended main body installation method

建議的機體安裝方法

- ① This product is suitable for the installation of the form of the smallest size as shown in the right figure. A window frame needs to be made according to the window and main body dimensions.

本產品適用於最小如右圖所示尺寸的窗體安裝，請根據窗體結構及機體尺寸製作窗體。

Window frame material: recommend the use of aluminum alloy.

窗體材質：推薦使用鋁合金

Window frame thickness: less than 30 mm

窗體厚度：小於30 mm

Notice
提示事項

It may be difficult to remove the filter if little clearance between louver and ceiling.

產品與天花板之間要確保有足夠的空間，否則會導致產品過濾網拆卸困難。

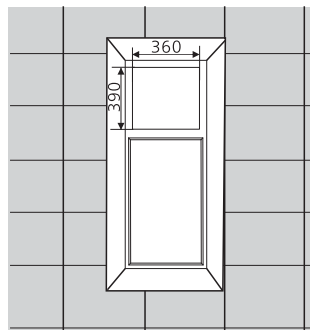

Unit: mm
單位: mm

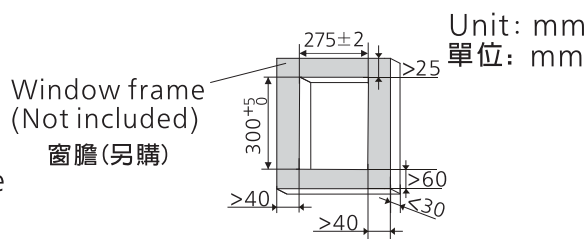

Window frame (Not included)
窗體(另購)

Unit: mm
單位: mm

- ② Fix the window frame onto the original window. (It must be can bear 5 times weight of the product.)

將窗體用可靠方法固定於原有窗框上。
(需能承受產品5倍的重量)

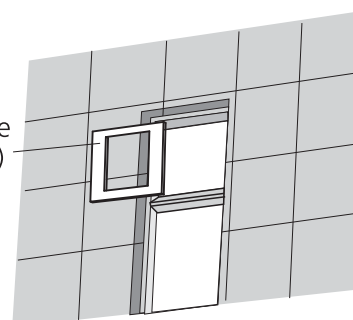

Window frame (Not included)
窗體(另購)

WARNING
警告

! Please be sure to take sufficient protection measure to prevent from high falling when install window frame.
安裝窗體時，請務必採取足夠的防護措施，以防窗體高空掉落。

- ③ Add silicone to seal around the flange of product, to make sure that the silicone cover the entire surface of sponge.

在產品法蘭邊周圍加玻璃膠，並確保玻璃膠覆蓋整個海綿表面。

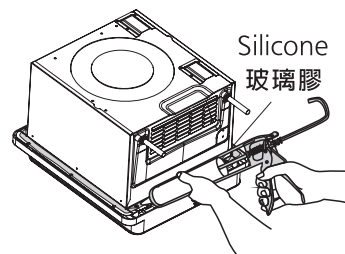

Silicone
玻璃膠

- ④ Please put the lower part of the product into the window sill first when it is installed, which to make sure the drain does not fall off.

將機體安裝到窗體時，先將機體下部放入窗體並確保排水管沒有脫落。

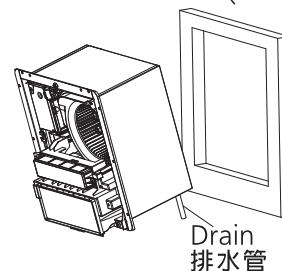

Drain
排水管

HOW TO INSTALL

安裝方法

- ⑤ Fix the main body onto the window frame with the supplied four $\phi 4 \times 25$ self-tapping screws.

使用附件包所提供的4顆 $\phi 4 \times 25$ 的自攻螺絲，將機體固定於窗簾。

$\phi 4 \times 25$ self-tapping screws
自攻螺絲
 $\phi 4 \times 25$



WARNING
警告

Properly install the main body according to the direction indicating label on the main body.

請按照機體上的方向指示標籤，正確安裝產品。

Otherwise, it may cause electric leakage.

否則可能會導致漏電。

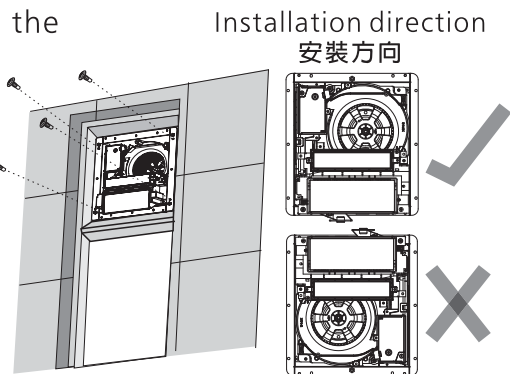

3. Connecting power cord

電源線的連接



WARNING
警告



Please select 60227 IEC 53(RVV) ordinary polyvinyl chloride sheathed cord. Nominal cross-sectional area of conductors is $3 \times 1.5 \text{ mm}^2$.
電源線請選用60227 IEC 53(RVV)型軟線，導線的截面積為 $3 \times 1.5 \text{ mm}^2$ 。



For the stripping length, please according to the wiring sketch (refer to figure 1). If the stripping length is too long, it may cause short circuit.
剝線長度，請按照剝線示意圖(右圖1)進行剝線，如剝線過長，可能會導致產品短路。



Do not damage the sheath of the power cord, otherwise an electric shock may be caused or short circuit.

電源線的絕緣膠不能破損，否則可能會導致觸電或短路。



Strand the core wire together after stripping, then insert them into about 8 mm deep position of the terminal block, ensuring that the part is under the spring slice, and no copper core cord is exposed outside. Make sure that the copper core cords are fixed by screws reliably (the recommended screw fixing torque is $0.49 \text{ N} \cdot \text{m}$) (See Figure 2). Otherwise an electric shock may be caused.

先將剝線後分散的銅芯線絞合在一起，然後伸入到端子台約8 mm深，並確保其在彈簧片的下方，切勿出現銅線外露現象。螺釘擰緊後，請確保銅線不易鬆脫(建議螺釘鎖緊扭矩為 $0.49 \text{ N} \cdot \text{m}$)，否則可能會導致觸電。(右圖2)

Wiring sketch
剝線示意圖

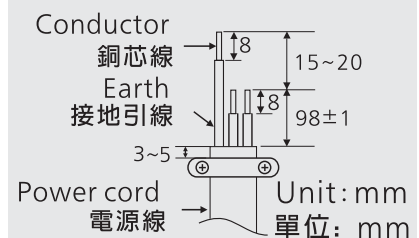

Figure 1
(圖1)

Terminal cutaway view
接線柱剖面圖

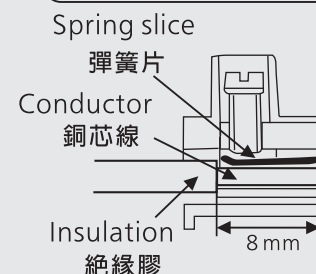

Figure 2
(圖2)

HOW TO INSTALL

安裝方法

- ① Install an all-pole switch with the contact separation not less than 3 mm and a leakage protection switch (with the leakage current lower than 30 mA) between the fixed wiring and the main body of this product.

請於固定佈線與本產品主機間安裝觸點開距不小於3 mm的“電源全極開關”及漏電保護開關(洩漏電流在30 mA以下)。

Notice 提示事項

Please select the suitable all-pole switch and leakage protection switch according to locally relevant Electricity and Wiring Regulations.

請根據當地相關的電力線路規範選擇合適的“電源全極開關”和“漏電保護開關”。

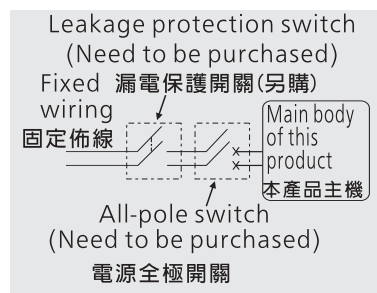

- ② Remove the screws (2 pcs) on the cord cover, and open the cord cover and the internal cord cover (by pushing the clamping position outward).

取下接線蓋板上的螺絲(2顆), 打開接線蓋板及內接線蓋板。

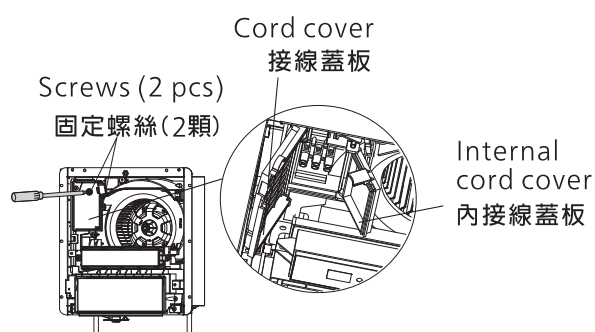
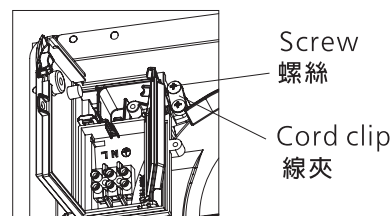
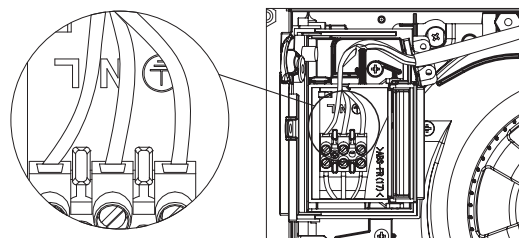

Diagram with the cover removed
打開後示意圖

- ③ Loosen the screws of the cord clip.
- 將固定電源線線夾的螺絲鬆脫。



- ④ Loosen the screws of the pillar terminal, insert the power cord (not supplied) connected to the indoor fixed wiring into the pillar terminal, tighten the screw, and guide the wire according to the right figure.
- 鬆開接線柱上的螺絲, 將接入室內固定線路的電源線(用戶自購)插入接線柱, 擰緊接線柱螺絲, 並按右圖進行理線。



- ⑤ Fix the power cord with the cord clip. (The cord clip must pin the insulation sheath of power cord.)
- As shown in Figure 1 of P9
用電源線線夾將電源線固定。
(電源線線夾必須壓住電源線的絕緣護套)
如第9頁圖1所示

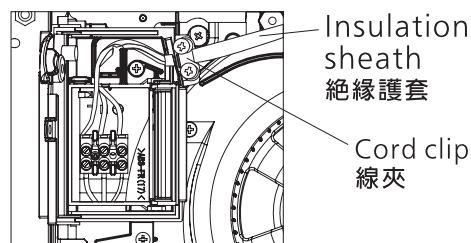

HOW TO INSTALL

安裝方法

- ⑥ Put the internal cord cover and the cord cover back on, and use the screw removed in Step ② to fix the cord cover again.

將內接線蓋板及接線蓋板重新蓋好，用步驟②拆下的螺絲，將接線蓋板重新固定。

Screws (2 pcs) 固定螺絲(2顆)

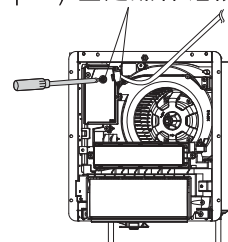

- ⑦ A power cord lead-out position is set at both the left and right sides of the main body, select one as required.

機體的左右兩側各設有一個電源線引出位，請根據實際情況進行選擇。

In the case of right wiring:
右側出線時：

- ① Remove Power cord clips A and B.
將電源線線夾A和線夾B拆下。

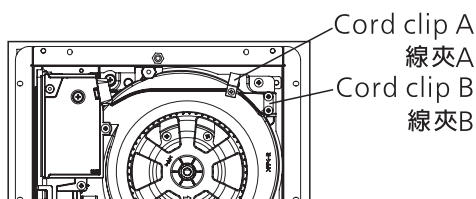

- ② Fix the power cord with Power cord clips A and B.
用電源線線夾A和線夾B固定電源線。

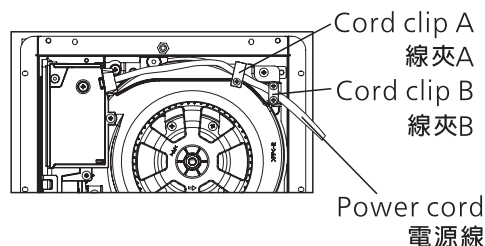

In the case of left wiring:
左側出線時：

- ① Remove Power cord clip A.
將電源線線夾A拆下。

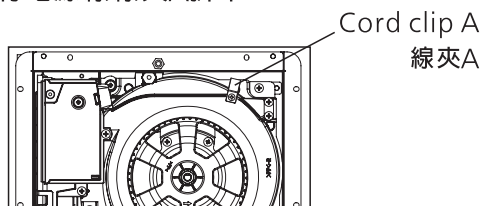

- ② Fix the power cord with Power cord clip A.
用電源線線夾A將電源線固定。

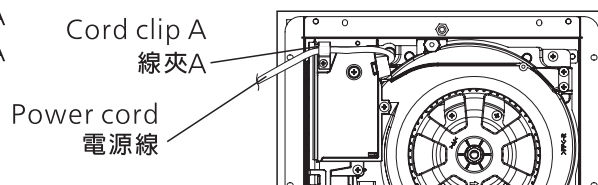

Notice
提示事項

Please be sure lead out the power cord as the figure position above. Otherwise, the filter may be unable to be installed.

請務必按圖示位置引出電源線，否則可能會導致過濾網無法安裝。

HOW TO INSTALL

安裝方法

4. Installing louver assembly 面板組合安裝

- ① At the power cord lead-out side (left or right), cut the outlet of the louver assembly by tools according to the groove shape on the back (nipper pliers) of the body assembly. (Take left outlet of power cord for example)

面板組合的左右兩邊各設有一個電源線出線口，使用工具(如尖嘴鉗等)按照出線口的凹槽形狀剪出電源線引出側的出線口。(以左側出線為例)

Notice
提示事項

Please remove the burrs of wire outlet before leading out the power cord. Otherwise the power cord may be damaged.

請把出線口的披鋒處理後再引線，否則披鋒可能會割傷電源線。

- ② Pull out the filter.
將過濾網抽出。

- ③ Insert a slotted screwdriver into the gap in the screw cap and open the screw cap outwards.
用一字螺絲刀插入螺絲蓋的縫隙，往外撬開螺絲蓋。

- ④ To install louver assembly, first put the hook on the right side of the louver into the product, and then clamp the card slots in bottom louver assembly in the grooves on the bottom main body. Fix the panel to the body.
安裝面板組合，先將面板右側的掛鉤扣入機體，再把面板組合底部卡位卡入機體底部凹槽，將面板組合固定於機體。

- ⑤ Make sure that the power cord is led out from the corresponding louver assembly outlet.
確保電源線從相應的面板組合出線口引出。

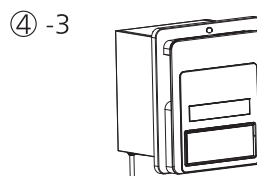
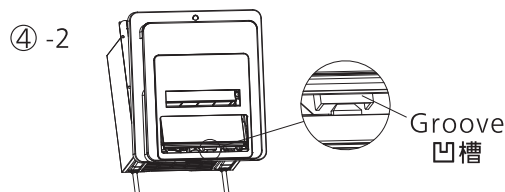
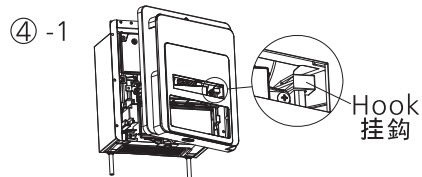
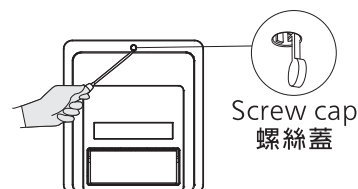
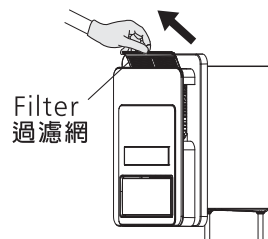
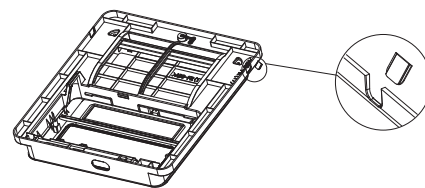

HOW TO INSTALL

安裝方法

- ⑥ Fix the louver assembly onto the main body with the supplied one M4×10 machine screws.
使用附件包所提供的1顆M4×10的機械螺絲，將面板組合固定於機體。

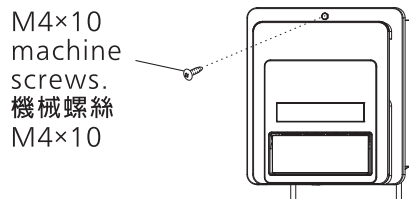

- ⑦ Recover the screw cap.
重新蓋上螺絲蓋。

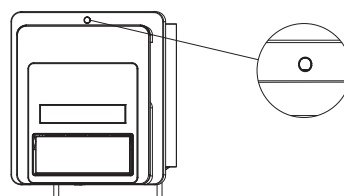

- ⑧ Install the filter.
裝上過濾網。

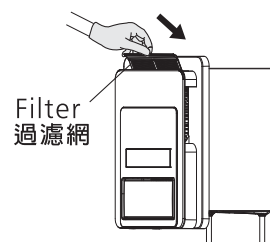

5. Installing the remote control 遙控器的安裝

- ① Take out the remote control from the holder.
把遙控器從遙控器底座抽出。

Remote control
遙控器

- ②-1 Check the main body can receive the signal from the intended remote control installation location. If remote control can not receive the signal from this installation location, please choose another installation location, or operate the remote control toward product after taking out it from the holder. The installation location cannot be toward the direct spraying area of the shower.

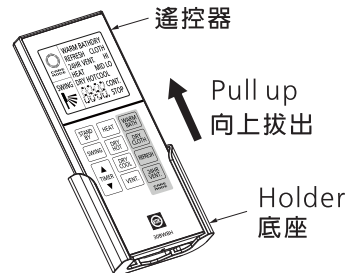

遙控器安裝前，請在預定安裝的位置上檢測機體接收信號的效果，若該位置無法使機體正常接收，請另選擇合適的位置或使用時把遙控器從底座中取出對著機體進行操作。且安裝位置應避免在花灑直淋處。

- ②-2 Open two $\phi 6$ holes in the bathroom wall as shown below. And install the controller holder.

在浴室的牆壁上開2顆 $\phi 6$ 的安裝孔，將遙控器底座安裝於牆上。

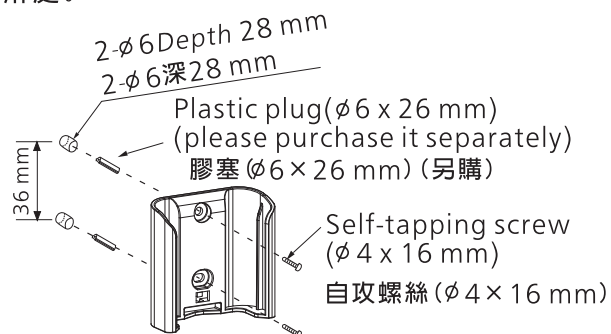

HOW TO INSTALL

安裝方法

- ③ Install two R03(AAA) Carbon batteries in the remote control.
將2粒R03(AAA)碳性電池放入遙控器中。

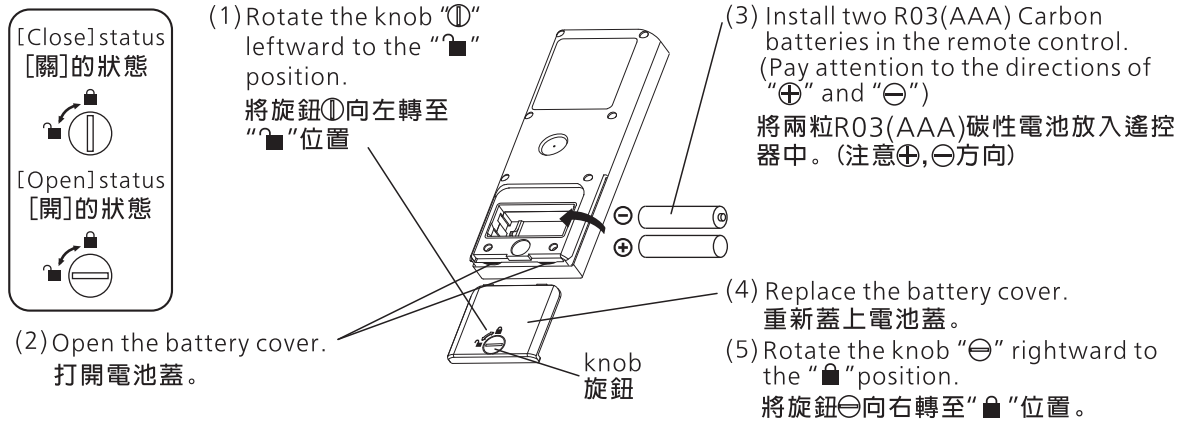

- ④ Please put back the remote control to the holder.
將遙控器放回遙控器底座。

⚠ WARNING 警告



■ Please observe the following when using the batteries.
電池的使用請遵守以下內容。

- Do not inversely install the positive pole and negative pole of batteries.
勿將電池正負反裝。
- Do not short circuit.
不可短路。
(Otherwise, a leakage or damage may be caused.)
(否則可能會導致漏液或破損)。
- Do not use an old battery together with a new battery or use different types of batteries in a mixed way.
勿將新舊、異種電池混合使用。

Notice 提示事項

- 1.If you will not use the remote control for a period of time, take out the batteries.
長期不使用時，請取出電池。
 - 2.Do not replace the batteries when the remote control body is wet.
更換電池時，請擦乾遙控器機體後進行更換。
 - 3.Do not exert too hard when you rotate the"⓪" knob on the remote control back, otherwise the knob will be damaged.
旋動遙控器背部⓪字旋鈕時，請勿用力過大，否則可能會損壞該旋鈕。
 - 4.Please be careful with picking up remote control, to avoid dropping and cause damage.
拿取遙控器時請小心，以免遙控器掉落導致損壞。
 - 5.Please don't install remote control and product in the same plane, otherwise, it may cause product out of control.
請勿將遙控器與產品安裝於同一平面，否則可能會導致無法遙控產品。
 - 6.Please don't immerge the remote control into water.
請勿將遙控器浸入水中。
- Please comply with local laws and regulations when disposing the battery.
丟棄電池時，請遵循當地法律法規。

TEST RUN

試運轉

■ After connecting the power, please check the following item using the remote control:

- Does the fan revolve normally?
- Does it have abnormal vibration or noise?
- Does it blow out hot air?
- Is each button on remote control just as its right function?

接通電源，按動遙控器上各個功能按鍵，檢查以下項目：

- 扇葉是否正常旋轉？
- 是否有不正常的震動或者噪音？
- 是否有熱風吹出？
- 遙控器上的各個功能按鍵的功能是否正常？

FUNCTION OF REMOTE CONTROL

遙控器功能

STANDBY button 待機按鈕

- In the heating or hot drying mode running for more than 30 seconds, press the **STANDBY** button to stop the heater. The fan will stop running after a delay of 10 seconds.
- In the standby status, this product still requires power consumption of 0.5 W. If the product will not be in use for a long time, the all-pole power switch should be turned off to disconnect the power supply for the purpose of energy saving.
- 當在暖氣、熱乾燥功能運轉達30秒以上，按 **STANDBY** 按鈕，加熱器將停止工作，扇葉延時10秒後停止工作。
- 本產品處於待機狀態時，仍有 0.5 W 的功耗。如長時間不使用時，應使用電源全極開關斷開電源，以節省能源。

SWING button 風向按鈕

Change the air direction (FIXED/AUTO)
切換風向設置 (固定/自動)

TIMER button 定時按鈕

Prolong the set time
延長定時時間

TIMER button 定時按鈕

Shorten the set time
縮短定時時間

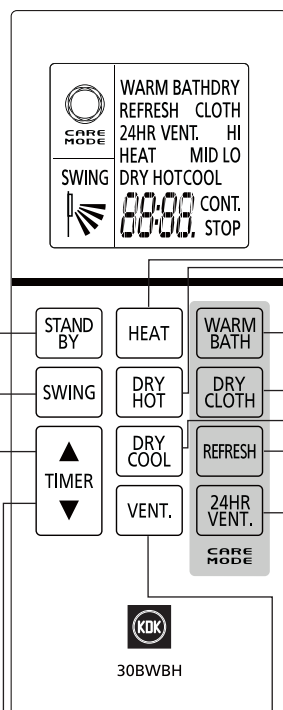

HEAT button 暖氣按鈕

Heating function
暖氣功能

DRY HOT button 熱乾燥按鈕

Dry hot function
熱乾燥功能

DRY COOL button 涼乾燥按鈕

Dry cool function
涼乾燥功能

CARE MODE 貼心模式

WARM BATH button 溫暖沐浴按鈕

Warm bath function
溫暖沐浴功能

DRY CLOTH button 高效乾衣按鈕

Dry cloth function
高效乾衣功能

REFRESH button 極速排氣按鈕

Refresh function
極速排氣功能

24HR VENT. button 24小時換氣按鈕

24hr vent. function
24小時換氣功能

VENT. button 換氣按鈕

Air exchange function
換氣功能

HOW TO USE TIMER FUNCTION

定時功能的使用方法

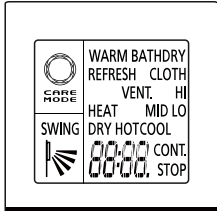

For adjusting running time
調整運轉時間時使用

During running, you can press the button to change the running time.

運轉中可通過 調整運轉時間。

① Each time you press the button, the time increases accordingly.

每按一次 按鈕，時間會隨之遞增；

Each time you press the button, the time decreases accordingly.

每按一次 按鈕，時間會隨之遞減；

② If you press and hold the button, the running time keeps changing.

如連續按，運轉時間會連續快速變換。

③ After the running time is set once, the system will automatically memorize the last running time of each mode.

設置一次運轉時間後，會自動記憶每個模式上一次的運轉時間。

To cancel the automatic memory content, press and hold the button for 3 seconds.

取消自動記憶內容，請長按 按鈕3秒。

HEAT mode 暖氣模式		
5 MIN.	~ 3 HOUR	Default settings 出廠設置為 15 MIN.
VENT. mode 換氣模式		
5 MIN.	~ 12 HOUR ~ CONT.	Default settings 出廠設置為 15 MIN.
DRY HOT mode 熱乾燥模式		
5 MIN.	~ 6 HOUR	Default settings 出廠設置為 15 MIN.
DRY COOL mode 涼乾燥模式		
5 MIN.	~ 12 HOUR ~ CONT.	Default settings 出廠設置為 15 MIN.
CARE MODE - WARM BATH mode 貼心模式 - 溫暖沐浴模式		
5 MIN.	~ 1 HOUR	Default settings 出廠設置為 15 MIN.
CARE MODE - DRY CLOTH mode 貼心模式 - 高效乾衣模式		
5 MIN.	~ 6 HOUR	Default settings 出廠設置為 15 MIN.
CARE MODE - REFRESH mode 貼心模式 - 極速排氣模式		
5 MIN.	~ 1 HOUR	Default settings 出廠設置為 15 MIN.

※ In the above running mode, each time you press the button, the time changes at the step of 5 minutes; one hour later, the time will change at the step of 30 minutes.

在上記運轉模式中每按一次 按鈕，時間會以5分進行增減，1小時后時間會以30分鐘進行增減。

HOW TO USE AIR DIRECTION FUNCTION

風向功能的使用方法

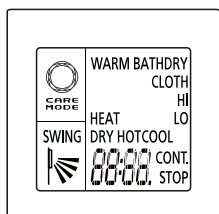
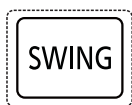

SWING

For adjusting air direction
調整風向時使用

During running, you can press the SWING button to adjust the air direction.

運轉中可通過 SWING 按鈕，調整上下風向。

During running, you can adjust the left and right wing direction manually. (The left and right maximum adjustment angles are 40 degrees each)

運轉中可手動調整左右風向
(左右最大調整角度各為40度)

※ Please do not grasp the blade by hand to adjust the left and right wind direction.

請不要用手抓住葉片調節左右風向。

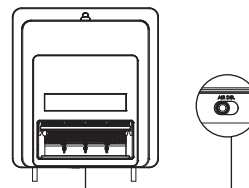

① The initial air direction setting of HEAT, DRY HOT and DRY COOL is AUTO. You can press the SWING button change the mode between AUTOMATIC and FIXED.

暖氣、熱乾燥、涼乾燥的風向初始設置為自動，通過 SWING 鍵，可進行自動與固定的切換。

* HEAT, DRY COOL: The baffle plate swings upward and downward within the range of about 25° to 85°

DRY HOT: The baffle plate swings upward and downward within the range of about 45° to 85°

暖氣、涼乾燥：導風板在約25度~85度的範圍內上下擺動。

熱乾燥：導風板在約45度~85度的範圍內上下擺動。

* FIXED: To fix the baffle plate angle, press the SWING button then the baffle plate turns to the required position. The baffle plate will stop.

固定：需固定導風板角度時，待導風板轉到所需位置，按 SWING 按鈕，導風板將停止轉動。

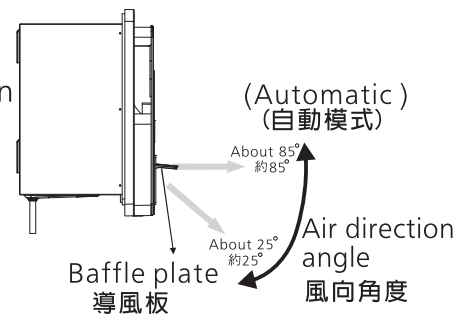

② Air direction cannot be set in the ventilation status.
換氣狀態下不可進行風向設置。

③ Each mode will automatically memorize the air direction position set this time.

各模式會自動記憶本次所設置的風向模式。

To cancel the automatic memory content, press and hold the STAND BY button for 3 seconds.

取消自動記憶內容，請長按 STAND BY 按鈕3秒。

HOW TO USE HEATING FUNCTION

暖氣功能的使用方法

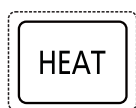

HEAT

Use when you feel cold in a bath
在沐浴中感到冷時使用

Before taking a bath, start the heating function to warm the bathroom beforehand.

在沐浴前開暖氣功能，可提前把浴室加溫。

- ① Press the **HEAT** button to start the heating mode at the HI. It will switch to the LO. mode if you press this button again.

按 **HEAT** 按鈕，暖氣模式以強檔開始運轉，再按一次將切換為弱檔。

(Initial settings)
(初始設置)

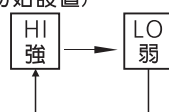

- ② During running, you can press **▲** **▼** to change the set time.
運轉過程中，可通過 **▲** **▼** 調整設置時間。
- ③ During operation, you can press the **SWING** button to adjust up and down air direction.
運轉過程中，可通過 **SWING** 按鈕，調整上下風向。
- ④ This product will stop automatically when the set time is up.
運轉完所設置時間後，本機會自動停止。
- ⑤ To stop midway in running, press the **STAND BY** button.
如需在運轉途中停止，請按 **STAND BY** 按鈕。

※ In the heating mode running for 30 seconds above, press the **STAND BY** button to stop the heater. The fan will stop running after a delay of 10 seconds.
若在暖氣模式運轉30秒以上，按 **STAND BY** 按鈕後，為使加熱器冷卻，扇葉將延遲10秒停止運轉。

1. Hot startup function: After the product starts up in the strong heating mode when the temperature in the bathroom is lower than 20 °C, it enters the hot startup status to avoid blowing of cold air, and the fan runs at a low speed. When the temperature in the bathroom reaches 20 °C or above or after running for 60 seconds, the hot startup status stops and the fan runs at a high speed.

熱啟動功能：當浴室溫度低於20 °C時，以暖氣強檔模式啟動後，為避免冷風吹出，產品進入熱啟動狀態，扇葉以低速運轉，待浴室溫度達至20 °C以上或經過60秒後，熱啟動狀態停止，扇葉以高速運轉。

2. Heater may stop heating when temperature in bathroom is up to required degree, and may restart heating as the temperature in bathroom cools down.

當浴室內溫度上升到一定程度時，加熱器停止工作，待溫度下降到一定程度後，加熱器重新開始工作。

HOW TO USE DRYING FUNCTION

乾燥功能的使用方法



Use when you need to dry the bathroom
乾燥浴室時使用

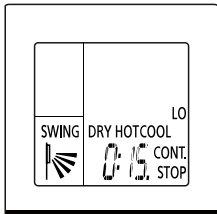
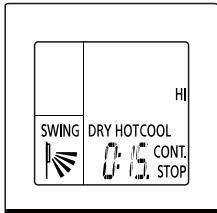
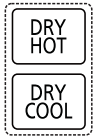

- ① Press the button to start the DRY HOT/DRY COOL mode at the HI..It will switch to the LO. mode if you press this button again.

按 按鈕，熱/涼乾燥模式以強檔開始運轉，再按一次將切換為弱檔。

(Initial settings)
(初始設置)

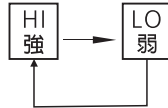

- ② During running, you can press to change the set time.
運轉過程中，可通過 調整設置時間。
- ③ During operation, you can press the button to adjust up and down wing direction.
運轉過程中，可通過 按鈕，調整上下風向。
- ④ This product will stop automatically when the set time is up.
運轉完所設置時間後，本機會自動停止。
- ⑤ To stop midway in running, press the button.

如需在運轉途中停止，請按 按鈕。

※ In the DRY HOT mode running for 30 seconds above, press the button to stop the heater. The fan will stop running after a delay of 10 seconds.

若在熱乾燥模式運轉30秒以上，按 按鈕後，為使加熱器冷卻，扇葉將延時10秒停止運轉。

HOW TO USE VENTILATION FUNCTION

換氣功能的使用方法

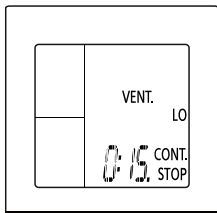
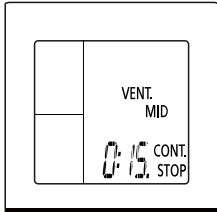
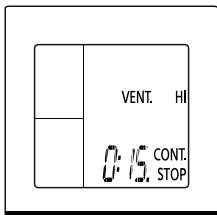

Use to ventilate the bathroom
浴室換氣時使用

- ① Press the button to start the air change mode at the HI. It will switch to the MID. mode or LO. mode if you press this button in turn.

按 按鈕，換氣模式以強檔開始運轉，再次按下將依次切換為中檔、弱檔。

(Initial settings)
(初始設置)

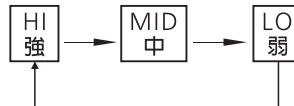

- ② During running, you can press to change the set time.
運轉過程中，可通過 調整設置時間。
- ③ This product will stop automatically when the set time is up.
運轉完所設置時間後，本機會自動停止。
- ④ To stop midway in running, press the button.

如需在運轉途中停止，請按 按鈕。

CARE MODE - HOW TO USE WARM BATH FUNCTION

貼心模式 – 溫暖沐浴功能的使用方法

WARM BATH Use when you feel cold in a bath
在浴室中感到冷時使用

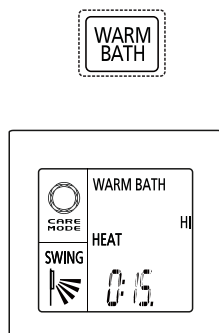

Before taking a bath, start the heating function to warm the bathroom beforehand.

在沐浴前開舒適暖氣功能，可提前把浴室加溫。

- ① Press the **WARM BATH** button to start the heating mode at the HI. It will switch to the VENT. mode at the HI. automatically when the set time is up. After 3 minutes, it will switch to the VENT. mode at the LO. automatically and run continuously.

按 **WARM BATH** 按鈕，溫暖沐浴模式以暖氣強檔開始運轉。運轉至所設時間後自動進入換氣強檔模式，運轉三分鐘後自動進入換氣弱檔模式並連續運轉。

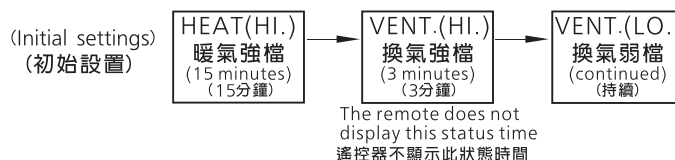

- ② During running, you can press **▲** **▼** to change the set time. (After heating, enter the ventilation state, the time is not adjustable.)

運轉過程中，可通過 **▲** **▼** 調整設置時間。

(暖氣結束後，進入換氣狀態，時間不可調。)

- ③ During operation, you can press the **SWING** button to adjust up and down wing direction. (After heating, enter the ventilation state and the wind direction is not adjustable.)

運轉過程中，可通過 **SWING** 按鈕，調整上下風向。

(暖氣結束後，進入換氣狀態，風向不可調。)

- ④ To stop midway in running, press the **STAND BY** button.

如需在運轉途中停止，請按 **STAND BY** 按鈕。

- ※ In the heating mode running for 30 seconds above, press the **STAND BY** button to stop the heater. The fan will stop running after a delay of 10 seconds.

若在暖氣模式運轉30秒以上，按 **STAND BY** 按鈕後，為使加熱器冷卻，扇葉將延遲10秒停止運轉。

1. Hot startup function: After the product starts up in the heating mode when the temperature in the bathroom is lower than 20 °C, it enters the hot startup status to avoid blowing of cold air, and the fan runs at a low speed. When the temperature in the bathroom reaches 20 °C or above or after running for 60 seconds, the hot startup status stops and the fan runs at a high speed.

熱啟動功能：當浴室溫度低於20 °C時，以暖氣模式啟動後，為避免冷風吹出，產品進入熱啟動狀態，扇葉以低速運轉，待浴室溫度達至20 °C以上或經過60秒後，熱啟動狀態停止，扇葉以高速運轉。

2. Heater may stop heating when temperature in bathroom is up to required degree, and may restart heating as the temperature in bathroom cools down.

當浴室內溫度上升到一定程度時，加熱器停止工作，待溫度下降到一定程度後，加熱器重新開始工作。

CARE MODE - HOW TO USE REFRESH FUNCTION

貼心模式 – 極速排氣功能的使用方法



Use to ventilate the bathroom
浴室換氣時使用

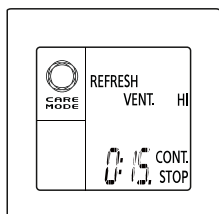

- ① Press the button to start the VENT. mode at the HI. It will switch to the VENT. mode at the LO. automatically when the set time is start and run continuously.

按 按鈕，極速排氣模式以換氣強檔開始運轉。運轉至所設時間後自動進入換氣弱檔模式並連續運轉。

(Initial settings)
(初始設置)

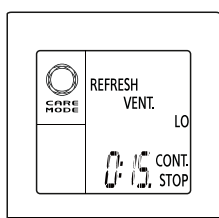
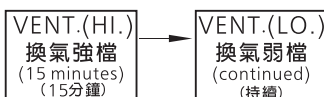

- ② During running, you can press to set the ventilation time.
運轉過程中，可通過 調整設置換氣強檔時間。
- ③ To stop midway in running, press the button.
如需在運轉途中停止，請按 按鈕。

CARE MODE - HOW TO USE 24HR VENT. FUNCTION

貼心模式 – 24小時換氣功能的使用方法



Use for ventilate the bathroom continuously
想對浴室持續換氣時使用

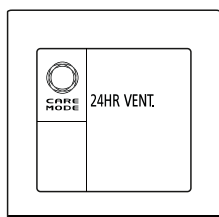

- ① Press the button to start the 24HR VENT. mode to ventilate the bathroom continuously.
按 按鈕，24小時換氣模式開始運轉。
- ② Air direction and time cannot be set in the 24HR VENT. mode.
24小時換氣模式不可進行風向、時間設置。
- ③ To stop running, press the button.
如需停止，請按 按鈕。

CARE MODE - HOW TO USE DRY CLOTH FUNCTION

貼心模式 – 高效乾衣功能的使用方法

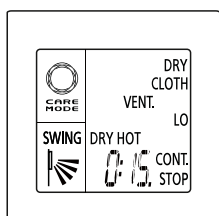
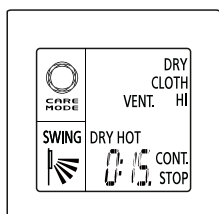

Use when you need to dry clothes
乾衣物時使用

- ① Press the **DRY CLOTH** button to start the DRY HOT mode at the HI. It will switch to the VENT. mode at the LO. automatically when the set time is start and keep running.

按 **DRY CLOTH** 按鈕，高效乾衣模式以熱乾燥強檔開始運轉。運轉至所設時間後自動進入換氣弱檔模式並持續運轉。



- ② During running, you can press **▲** **▼** to change the set time. (After the dry hot mode, enter the ventilation state, the time is not adjustable.)

運轉過程中，可通過 **▲** **▼** 調整設置時間。

(熱乾燥強檔模式結束後，進入換氣狀態，時間不可調。)

- ③ During operation, you can press the **SWING** button to adjust up and down wing direction. (After the dry hot mode, enter the ventilation state and, wind direction is not adjustable.)

運轉過程中，可通過 **SWING** 按鈕，調整上下風向。

(熱乾燥強檔模式結束後，進入換氣狀態，風向不可調。)

- ④ To stop midway in running, press the **STAND BY** button.

如需在運轉途中停止，請按 **STAND BY** 按鈕。

- ※ In the heating mode running for 30 seconds above, press the **STAND BY** button to stop the heater. The fan will stop running after a delay of 10 seconds.

若在熱乾燥模式運轉30秒以上，按 **STAND BY** 按鈕後，為使加熱器冷卻，扇葉將延遲10秒停止運轉。

Heater may stop heating when temperature in bathroom is up to certain degree, and may restart heating as the temperature in bathroom cools down.

當浴室內溫度上升到一定程度時，加熱器停止工作，待溫度下降到一定程度後，加熱器重新開始工作。

CARE MODE - HOW TO USE DRY CLOTH FUNCTION

貼心模式 – 高效乾衣功能的使用方法

To use the drying function to dry clothes, you are suggested to set the product as shown below:

使用乾燥功能進行衣物烘乾時，建議按照下圖進行設置：

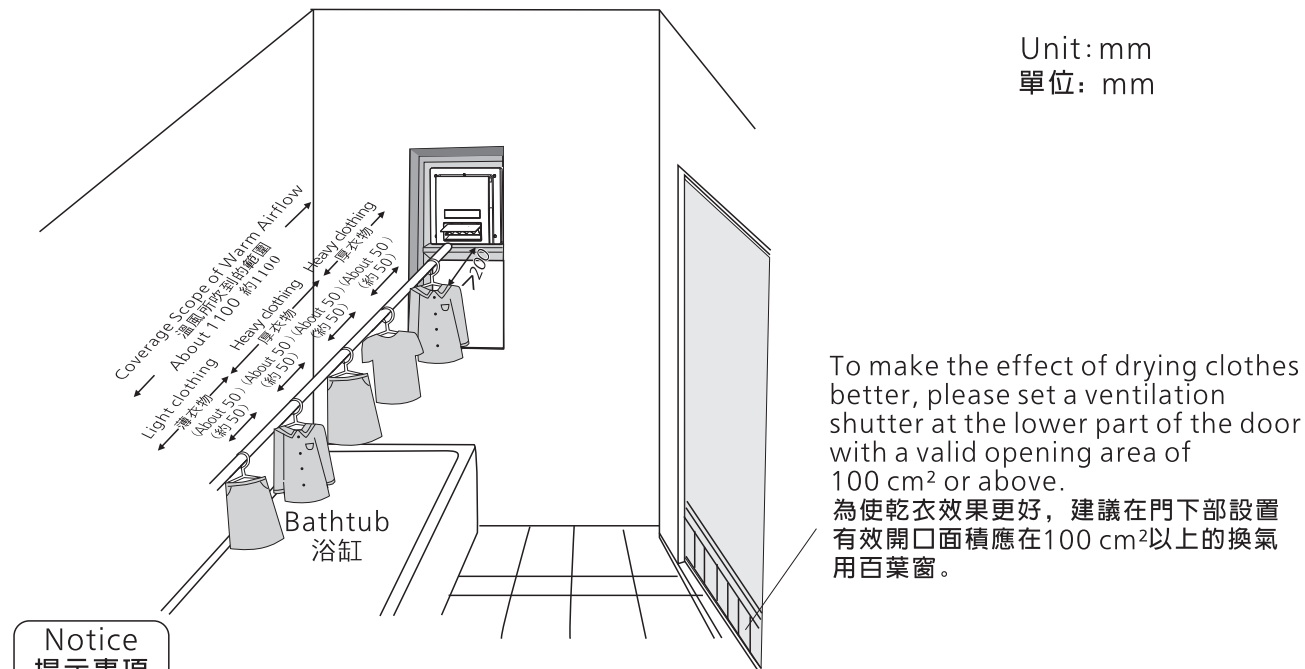

Notice 提示事項

- When water drops remain on the bathroom walls or the floor, the clothes drying time will be prolonged. Use a dry cloth to wipe away water drops in advance.
浴室牆壁或地板殘留水滴時，會導致衣物乾燥時間延長，請事前用乾布等擦拭乾淨。
- To spread the warm airflow, keep a space (More than 50 mm) between clothes.
為使溫風遍佈，衣物間要保留間隔(50 mm以上)。
- Hang heavy clothing near the warm airflow outlet to dry them more quickly.
厚衣物掛在溫風出風口附近會更易乾。
- The clothes must be 200 mm or above away from the air outlet. (The clothes may be discolored if the distance is too short.)
衣物離出風口必須保證在200 mm以上。(如果太近可能會導致衣物變色)
- The clothes at the back end of the clothesline pole cannot be dried quickly. In the midway of drying, you can swap the positions of fast-drying clothes near the product with those at the back end. (In the case of Auto air direction, the scope of about 1100 mm at the center is easily reached by the airflow, as shown in the figure.)
衣桿後端的衣物不易乾，在乾燥中途可將易乾的靠近產品端的衣物與後端衣物調換位置。(風向自動時，如圖所示中央約1100 mm為風易吹到的範圍。)
- Do not hang the clothes on product directly to dry.
請勿把衣物直接掛在產品上乾燥。
- The drying time varies with the bathroom size and type, room temperature, outside temperature and humidity, clothes types and quantities, and the dewatering status.
乾燥時間會因浴室的大小、種類、室溫、外界溫度、濕度、衣物種類、數量、脫水狀態而不同。
- The condition of the bathroom will affect the drying effect, please set the drying time according to the actual situation.
浴室的條件會影響乾衣效果，請根據實際情況，設置乾衣時間。
- When you dry clothes, make sure that the air blows to the clothes.
乾衣時，請確保風能夠吹到衣物。

CARE MODE - HOW TO USE DRY CLOTH FUNCTION 貼心模式 – 高效乾衣功能的使用方法

Installing the clothesline pole 需安裝掛衣桿時

Cautions for Installing clothesline pole:

安裝掛衣桿注意事項：

- Please select clothesline pole of rust resisting material which can withstand more than 5 kg load.
選購掛衣桿時，請務必選購每根可承受5 kg以上重量的不易生鏽的衣桿。
- Do not hang the clothesline pole on product directly.
請勿把掛衣桿直接搭在產品上。
- Be sure to install clothesline poles at the recommended position.
(The drying time will be prolonged if you install them at other positions.)
掛衣桿必須安裝於所推薦的位置。(如安裝於推薦以外的位置，會導致乾衣時間延長。)
- Do not set the clothes hook in an inclined condition.(Otherwise the distance of 200 mm away from the main body may not be insured.)
不要將衣掛傾斜放置。(否則可能不能確保與機體間的距離200 mm。)
- Make sure that the clothes rail and the product maintain a distance of more than 100 mm.
確保掛衣桿與產品保持100 mm以上的距離。

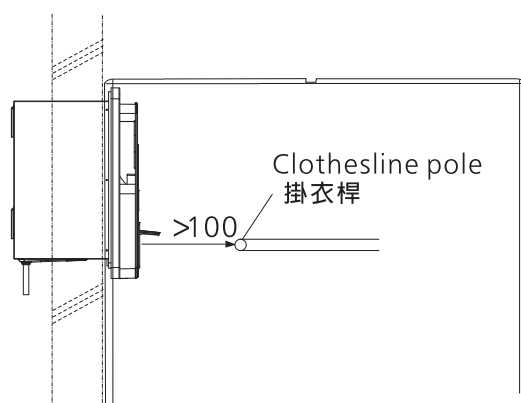

⚠ WARNING 警告

- ⚠ This appliance is intended only for drying textiles washed in water.
器具僅用於乾燥水洗的紡織物。
Otherwise, it may cause injury.
否則可能會導致傷害。

⚠ CAUTION 注意

- ⚠ Do not leave clothes too close to the air outlet.
禁止將衣物離出風口太近。
Otherwise, a fire may be caused.
否則可能會導致火災。

MODE BUTTON PANEL ON MAIN BODY

機體模式按鈕面板

When the remote control is lost or does not work, you can use the MODE button panel on the front surface of the main body to operate the product.
(Each time can be operated 15 mins)

當遙控器丟失或者無法正常使用時，可臨時通過機體面板正面的模式按鈕進行操作。
(每次可運轉15分鐘)

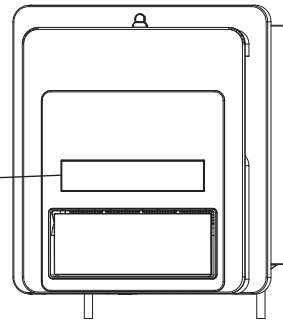
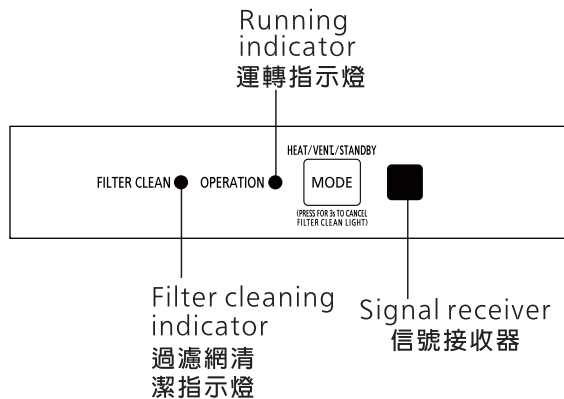

WARNING
警告

⚠

Do not press the MODE button during a bath or shower in the bathroom. Otherwise, you may slip.
避免意外滑倒，當在浴室沐浴時，請不要操作模式按鈕。

1. The MODE button can be used to switch among the following functions:

模式按鈕可進行下記功能的切換：



Conditions of the filter cleaning indicator and running indicator.

過濾網清潔指示燈及運轉指示燈的變化。

Run Status 運轉狀態	Filter cleaning indicator 過濾網清潔指示燈	Operation indicator 運轉指示燈
Stop 停止	Off 滅	Off 滅
Normal running 正常運轉	Off 滅	On 亮
Abnormal running 運轉異常	Off 滅	Blinking fast*1 快速閃爍
Normal running 正常運轉 + Filter cleaning indication 過濾網清潔提示	Blinking fast 快速閃爍	On 亮
During the hot startup 熱啟動功能時	Off 滅	Blinking slow*2 慢速閃爍

The product error means that a fault occurs or the main body fails to operate normally, when the running indicator blinks quickly.

Please disconnect the power supply, and contact customer consultation service center or our distributor.

產品異常主要指出現故障或主機失常時，運轉指示燈快速閃爍，請斷開電源，且與客戶諮詢服務中心或經銷商聯繫。

※1 Blinking fast: On for 0.5 seconds and off for 0.5 seconds
快速閃爍：0.5秒亮、0.5秒滅。

※2 Blinking slow: On for 1 second and off for 1 second
慢速閃爍：1秒亮、1秒滅。

USE AND MAINTENANCE INSTRUCTIONS

使用及維護注意事項



WARNING 警告

- To avoid low-temperature scalding, do not directly below the same part of the body with hot wind for a long time (2 hours or above).

請勿長時間(2小時或以上)讓熱風直接吹在身體同一位置。



Doing this may lead to low-temperature scald.
可能會導致低溫燙傷。

- Once flammable gas leaks, do not start any function of this product.

當發生煤氣洩漏時，禁止開啟本產品的任何功能。



Doing this may generate spark and thus lead to explosion.
可能會產生火花而引起爆炸。

- Do not directly spray this product with water and other liquids.

禁止用水及其他液體直接噴射本產品。

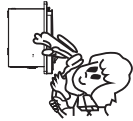

Doing this may lead to short circuit or electric shock.
可能會導致短路或觸電。

- Do not clean the heating part or let water flow into the electric motor or electrical parts.

加熱部件不需要進行清潔，且切勿讓水進入電動機及電器部件內。



Failure to following this may lead to electric shock.
否則可能會觸電。

- Do not put battery into fire or heat, break, modify it.

禁止將電池投入火中及加熱、分解、改造。



If the insulation or exhaust value is damaged, the battery may become hot, crack.

如損傷了絕緣物或排氣閥等，可能會導致電池漏液、發熱、破裂。

- Keep battery out of reach of children and infants.

禁止將電池放置在嬰幼兒可觸及到的地方。



If the battery is swallowed, seek medical help immediately.
萬一錯誤吞食，請從速求診。

- Do not use battery of skin peeling.



If the insulation or exhaust value is damaged, the battery may become hot, crack.
如損傷了絕緣物或排氣閥等，可能會導致電池漏液、發熱、破裂。

- Please promptly take out of the exhausted battery from the remote control.

用完的電池，請及時從遙控器中取出。



Otherwise, battery may leakage or rupture.
如放置不管，有可能會導致電池漏液或發熱、破裂。

- If the alkaline liquid of battery enter eyes, clean the eyes with lots of water and seek medical help immediately, but not rub eyes with hands.

電池的鹼性液體不慎進入眼內時，切勿用手揉擦眼睛，迅速使用大量清水充分洗淨和醫治。



Otherwise, it may cause blindness, etc.
否則可能會導致失明等。

- Before try to touch the main body of this product or clean this product, make sure that the "all-pole switch" connected to this product is disconnected.

在接觸本產品機體前和清潔本產品時，必須確保連接本產品的“電源全極開關”處於斷開狀態。



Failure to following this may lead to electric shock.
否則可能會觸電。

USE AND MAINTENANCE INSTRUCTIONS

使用及維護注意事項



WARNING 警告

- If the product will not be in use for a long time, please use the “all-pole power switch” to disconnect the power supply.

不使用產品時，請斷開“電源全極開關”。



Failure to following this may lead to electric shock.

否則可能會觸電。

- If you will not use this product any more, remove the product.

如以後不打算再使用本產品時，不得放置不管，而應予以拆除。



This product may cause injuries once it falls off.

萬一掉落，可能會導致受傷。

- Please observe the following with using the batteries.

電池的使用請遵守以下內容。

- Do not inversely install the positive pole and negative pole of batteries. 勿將電池正負反裝。
- Do not use an old battery together with a new battery or use different types of batteries in a mixed way. 勿將新舊、異種電池混合使用。
- Do not short circuit. 不可短路。



(Otherwise, a leakage or damage may be caused.)

(否則可能會導致漏液或破損。)

- Do not disassemble this product for repair or reconstruction.

禁止拆解本產品進行修理或改造。



Doing this may lead to fire and electric shock.

容易導致火災、觸電。



CAUTION 注意

- When you clean this product, please wear gloves.

清潔時請帶上手套。



Failure to follow this may lead to unexpected injury.

否則可能會導致受傷。

- Do not swing the baffle plate when the product is electrified.

在機體通電狀態下，請勿用手調整導風板。



Failure to follow this may lead to unexpected injury.

否則可能會導致受傷。

Notice 提示事項

1. When the baffle plate cannot be reset completely, you can press the STANDBY button immediately after pressing the DRY COOL button. Then, the baffle plate will be reset by a small angle. Repeat the operation until the baffle plate is reset completely.

當出現導風板復位不完全時，可通過按“涼乾燥”鍵後，立即按“待機”鍵，導風板將進行一個小角度的復位，如此重複操作，直到使導風板完全復位為止。

USE AND MAINTENANCE INSTRUCTIONS

使用及維護注意事項

- The applicable ambient temperature of this product is in the range of $-10^{\circ}\text{C}\sim 40^{\circ}\text{C}$, using it out of this range may cause a fault.
本產品適用環境溫度 $-10^{\circ}\text{C}\sim 40^{\circ}\text{C}$ ，否則可能會引起故障。
- Please stop operating the product during typhoon or similar weather with strong wind and rain.
颱風等強風雨天氣時，請停止使用本產品。
- The bathroom size may affect the heating performance of this product.
浴室大小的不同會影響本產品的暖房效果。

MAINTENANCE

維護方法

Cleaning Precautions 清潔注意事項

Cleaning the louver: 面板組合的清潔:

- To prevent color change and accelerated aging of the panel, do not use any type of diluent, alkaline cleaner, benzene, alcohol, antiseptic, or steel ball as shown below.

為避免導致面板變色及加速面板老化，請勿使用類似於圖示的各種稀釋劑、鹼性清潔劑、苯、酒精、殺菌劑或鋼絲球等。

- To use a chemical cloth, clean this product by following the instructions.

如使用化學抹布，請遵照其使用指示來清潔本產品。

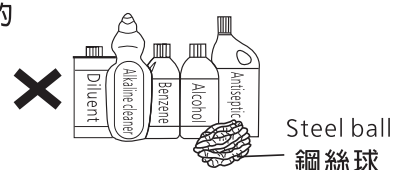

Cleaning the filter: 過濾網的清潔:

- Do not wash the filter with water, because water may destroy the anti-microbial performance of the filter; do not use a wire brush or any other hard tool to clean the filter, lest the filter would be damaged.
不可用水洗，因為水會破壞過濾網的抗菌性能；不可用鋼絲刷或其他硬質的工具來清潔以免損壞過濾網。
- When the filter cleaning indicator at the receiving part of the main body blinks, it is time to clean the filter according to setting of the main body. You need to clean the filter. (When the accumulated running duration reaches 2,200 hours (continuous running about three months), the filter cleaning indicator will blink.)
當機體接收部的過濾網清潔指示燈閃爍時，表示已達到機體所設定的清潔過濾網的時間，請清潔過濾網。(當運轉時間累計達到2200小時(約連續運轉3個月)，清潔指示燈就會閃爍。)
- To prevent dust accumulation in the filter which may block the air inlet, be sure to clean the filter before starting the product when product has not been in use for a period of time even if the filter cleaning indicator does not blink. Also, when the product is not often used, clean the filter regularly even if the filter cleaning indicator does not blink.
為防止灰塵積聚在過濾網上導致進風口堵塞，產品放置一段時間未使用時，即使過濾網清潔指示燈未閃爍，也請清潔過濾網後再運轉產品；產品使用頻率較低時，即使過濾網清潔指示燈未閃爍，也請定期清潔過濾網。

MAINTENANCE

維護方法

- ① Shut off the all-pole switch.
斷開“電源全極開關”。
- ② Wipe the louver assembly with a soft cloth.
用軟布擦拭面板組合。
- ③ Remove the filter from the slant upward side of louver assembly.
將過濾網從面板組合的斜上方取出。
- ④ Use a vacuum cleaner to remove dust and dirt from the filter.
Do not clean with water, otherwise the anti-microbial layer will be washed away.

用吸塵機清除過濾網上的灰塵和污垢。
請勿用水清洗，因會洗走過濾網表面的抗菌塗層。

- ⑤ Reinstall the filter assembly.
重新安裝過濾網組合。

Notice 提示事項

Please install the filter correctly and confirm that the filter is in place, otherwise it may cause dust to enter the body.

請正確安裝過濾網并確認濾網安裝到位，否則有可能會導致灰塵進入機體。

- ⑥ Turn on the all-pole switch.
開啟“電源全極開關”。
- ⑦ Clear the filter cleaning indication at the receiving part of the main body.
取消機體接收部過濾網清潔提示。

Each time cleaning the filter, you are advised to reset the accumulated time of the filter cleaning indication. (Press and hold the MODE button for about 3 seconds. A “beep” means the resetting is done.)

長按機體接收部模式按鈕約3秒，聽到“嘀”的一聲，過濾網清潔提示將被解除。（過濾網清潔指示的累計時間將復位，重新累計。）

The accumulated time of the filter cleaning indication will be reset, and the time will be accumulated again. (Press and hold the MODE button at the receiving part of the unit body for about 3 seconds. A “beep” means the filter cleaning indication is cleared.)

每次清潔過濾網後，建議將過濾網清潔提示的累計時間復位。（長按模式按鈕約3秒，聽到“嘀”的一聲，復位完成。）

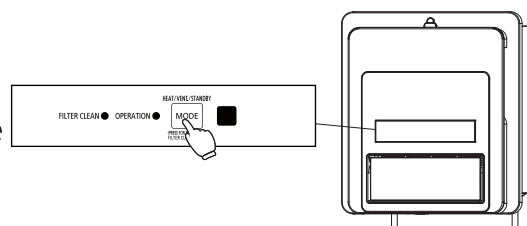
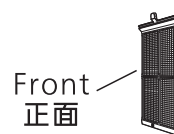
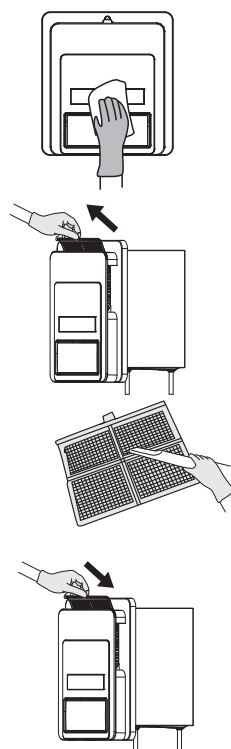

ANTIBACTERIAL FUNCTION

抗菌功能

- ※ The filter mesh in the filter mesh assembly provides the antibacterial function, with the antibacterial ratio against staphylococcus aureus and the antibacterial ratio against colibacillus up to 99.9% respectively (test basis: JIS Z2801)
- ※ After use for a period of time, the colour of the filter mesh will change from yellow to brown, but the change to material colour will not affect performance.
- ※ As the use time increases, the antibacterial performance of the filter mesh will decrease accordingly.
- ※ 過濾網組合中的過濾網具有抗菌功能，其對金黃色葡萄球菌抗菌率達到99.9%，大腸桿菌抗菌率達到99.9%。（檢測依據：JIS Z2801）。
- ※ 使用一段時間後，過濾網的顏色會從黃色變成茶色，這種材質顏色的變化並不影響性能。
- ※ 隨著使用時間的增加，過濾網的抗菌性能會相應減弱。

TROUBLESHOOTING

常見故障的識別與處理

Check the product according to the table below if a fault occurs. If an error occurs, check that the all-pole switch connected to this product is disconnected, and contact customer consultation service center or our distributor.

發生故障時請按下表進行檢查，如果問題仍然未能解決，請確保連接產品的“電源全極開關”處於斷開狀態，且與客戶諮詢服務中心或經銷商聯繫。

	Symptom 癥狀	Cause 原因	Troubleshooting 處理
Air 風	No hot wind blow out 無熱風吹出	The heater may fail 有可能是加熱器不良	Contact customer consultation service center or our distributor 請與客戶諮詢服務中心或經銷商聯繫
	Air volume reduced 風量變小	The filter may be blocked 有可能是過濾網堵塞	Clean the filter 請清潔過濾網
Remote control 遙控器	Remote control does not work 遙控器無法操作	The batteries may be exhausted 有可能是電池電量消耗完	Replace the batteries 請更換新電池
Mode button panel on main body 機體模式面板	The filter cleaning indicator blinks quickly 過濾網清潔指示燈快速閃爍	It's time to clean the filter 到達需清潔過濾網時間	Clean the filter 請清潔過濾網
Main body 機體	Rain water enter into bathroom 有雨水進入室內	The drain pipe may be blocked or installation problem 有可能是排水管堵塞或安裝不良	Contact customer consultation service center or our distributor 請與客戶諮詢服務中心或經銷商聯繫

WIRING DIAGRAM

電氣原理圖

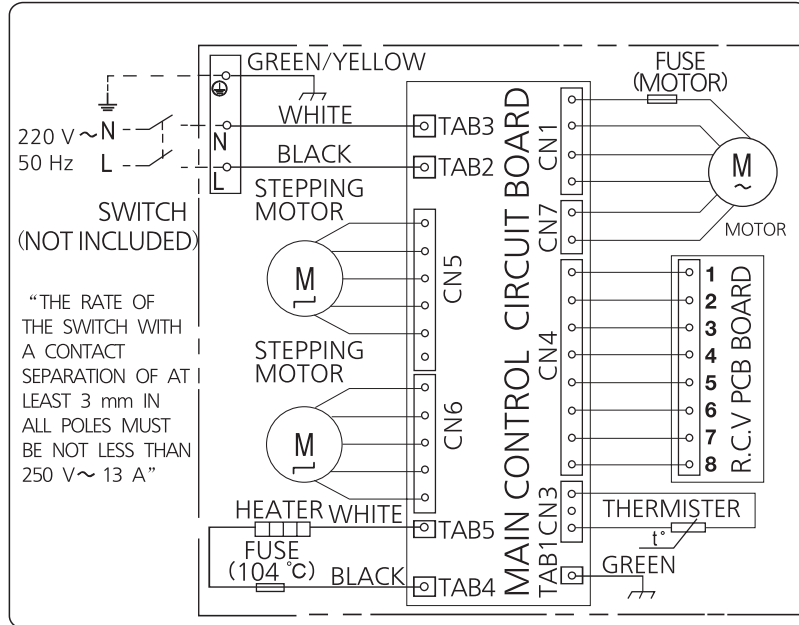

SPECIFICATIONS

規格

Model No. 型號	Rated Voltage 額定電壓 [V]	Rated Frequency 額定頻率 [Hz]	Power Consumption 額定輸入總功率 [W]	Rated Current 額定電流 [A]	Air Volume 換氣風量 [m ³ /h]			Weight 淨重 [kg]
					Hi高	Mid中	Low低	
30BWBH	220	50	1440	6.55	260	200	80	5.5

Power Consumption 功率 [W]							Noise 噪音 [dB]						
Heat 暖氣		Dry 乾燥		Vent 換氣			Heat 暖氣		Dry 乾燥		Vent 換氣		
		Hot 熱	Cool 涼						Hot 熱	Cool 涼			
Hi高	Low低			Hi高	Mid中	Low低	Hi高	Low低			Hi高	Mid中	Low低
1440	1420	1440	33	38	32	17	45	44	46	46	45	40	20

- Power consumption and rated current are obtained when the baffle plate is at maximum opening angle.
額定輸入總功率、額定電流值在導風板打開最大角度時測得。
- Air volume, electric specification and noise value are measured when static pressure is 0 Pa.
換氣風量、電氣特性、噪音值等數據是在靜壓為0 Pa狀態下的數值。
- Noise value is the weighted sound pressure grade A, which is the central value measured by this company, its tolerance range is from +3 dB to -7 dB. The method to measure is as follows: in an anechoic chamber, measure noise value first 1 m away from the left, right and beneath of the sample, then get the averaged value.
噪音值為A計權平均聲壓級，是本公司測試結果的中心值，有+3 dB，-7 dB的公差範圍。測試方法為在全消音噪聲測試室內，距樣品左側、右側、正前方各1米處測定其噪音值，然後取其平均值。
- Air volume is the central value measured by this company with $\pm 10\%$ of tolerance range.
換氣風量是本公司測試結果的中心值，有 $\pm 10\%$ 的公差範圍。
- This product and remote control comply with the IPX4 requirement against the water shower test.
本產品機體及遙控器通過防水試驗，符合IPX4要求。
- Insulation class E
E級絕緣

The above specification may be changed without further notice.
上述參數如有變動，恕不另行通知。

KDK Company, Division of PES
Head Office: 4017, Takaki-cho, Kasugai, Aichi, Japan

© KDK Company, Division of PES 2018-2023

Issue date 發行: 04/2023
P1018-4043 30BWB4200DH